



TRENCHING & SHORING

4.0m Standard Manhole Box Technical Data Sheet

This technical data sheet provides essential information for users of the GAP Group 4.0m Standard Manhole Box System. It highlights key aspects of the Manhole Box Assembly, installation, weight, dimensions, planning, and lifting operations, which should be considered when compiling method statements.

Overview

The 3.5m Standard Manhole Box is a four-sided mechanical excavation support system designed to support trenches up to **5.5m deep**. It is specifically intended for use in manhole construction and is not suitable for other purposes.

System Features

- **Depth Capacity:** Up to 5.5 meters (achievable with 1 base and 2 extensions).
- **Manhole Ring Sizes:** Suitable for ring sizes of 2100mm, 2400mm and 2700mm.
- **Maximum Lateral Earth Pressure:** 35kN/m²
- **Application:** Designed for use with GAP's manhole shutters, enabling rapid manhole construction without the need for workers to enter unsupported excavations.
- **Installation Methods:** Can be installed by an excavator using either the dig and push or excavate and lower method.

Weight

- **Complete Base Box:**
 - Weight: 3856 kg
 - Components: 2 panels, 4 struts, pins and R-clips
- **Complete Extension Box:**
 - Weight: 2786 kg
 - Components: 2 panel, 2 struts, pins and R-clips

Planning & Safety Considerations

When planning for the use of the 4.0m Standard Manhole Box, consider the following:

- **Lifting Operations:** Ensure that the excavator's lifting capacity is sufficient to handle the manhole box components.
- **Assembly & Installation:** Follow safe practices and procedures for assembling and installing the manhole box, as outlined in your method statement.
- **Site Conditions:** Assess site conditions such as soil type, trench depth, and groundwater levels before installation.

Important Notes

- It is assumed that users are familiar with general safety practices relevant to manhole box operations.

For further information or assistance, please contact GAP Group.

Box Component Identification, Range and Dimensions

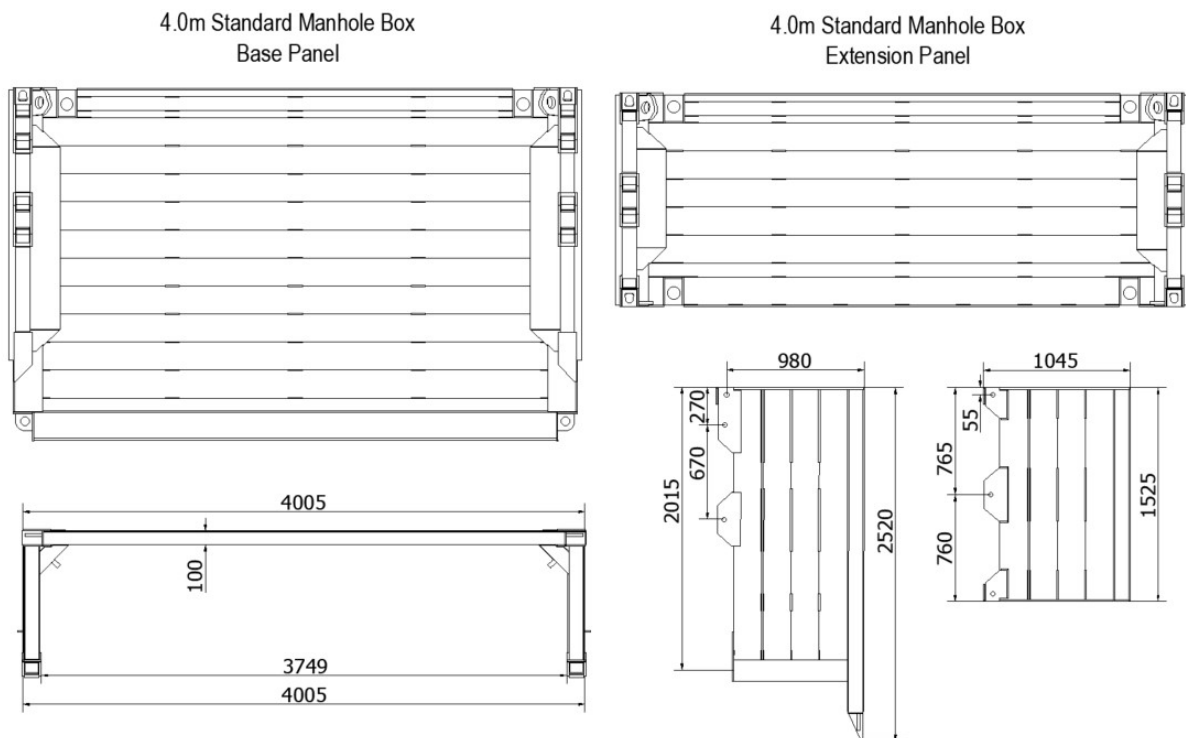

Pin and Struts

There are 8No. pins and R-clips and 4No. connectors required to attach one base box to the extension box.

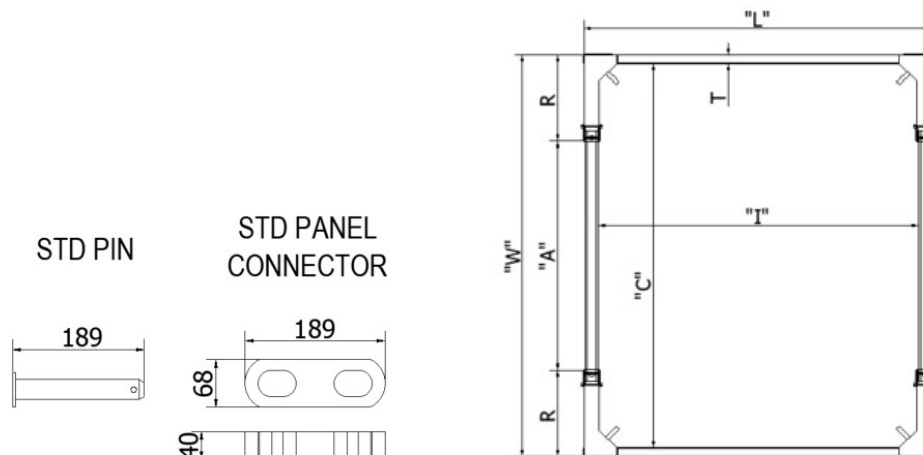



Strut Type	"A"		"R" Outside Face to Pin Centre (mm)	"C"		"I" Internal Clearance (mm)	"W"		Clearance Below Lower Strut (mm)	"L" Overall Length (mm)
	Pin to Pin Length (mm)			Internal Clearance (mm)	Overall Width (mm)					
	Min	Max	Min		Max	Min	Max			
Size 0	480	680	980	2240	2440	3750	2440	2640	1500	4005
Size 1	680	1080	980	2440	2840	3750	2640	3040	1500	4005
Size A	1150	1950	980	2910	2710	3750	3110	3910	1500	4005
Size B	1900	2700	980	3660	4460	3750	3860	4660	1500	4005
Size C	2650	3450	980	4410	5210	3750	4610	5410	1500	4005
*2.0m	750		980	2510		3750	2710		1500	4005
*2.5m	1250		980	3010		3750	3210		1500	4005
*3.0m	1750		980	3510		3750	3710		1500	4005
*3.5m	2030		980	3790		3750	3990		1500	4005
*4.0m	2250		980	4010		3750	4210		1500	4005
*4.5m	2530		980	4290		3750	4490		1500	4005
*4.7m	2730		980	4490		3750	4690		1500	4005

***Struts are fixed.**

Struts: There are two types of struts for Standard manhole and Trench boxes.

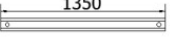
Fixed Standard Struts Manhole Box

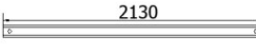
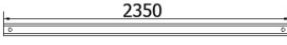
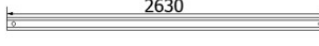
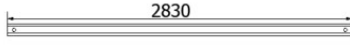
2.0m STRUT	
2.5m STRUT	
3.0m STRUT	
3.5m STRUT	
4.0m STRUT	
4.5m STRUT	
4.7m STRUT	

Standard Struts Manhole Box

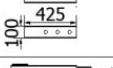
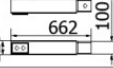
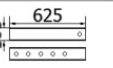
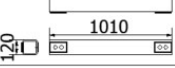
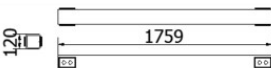
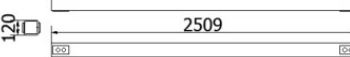
SIZE 0 OUTER STRUT	
SIZE 0 INNER STRUT	
SIZE 1 OUTER STRUT	
SIZE 1 INNER STRUT	
A DOUBLE ENDED OUTER STRUT	
B DOUBLE ENDED OUTER STRUT	
C DOUBLE ENDED OUTER STRUT	

Site Assembly

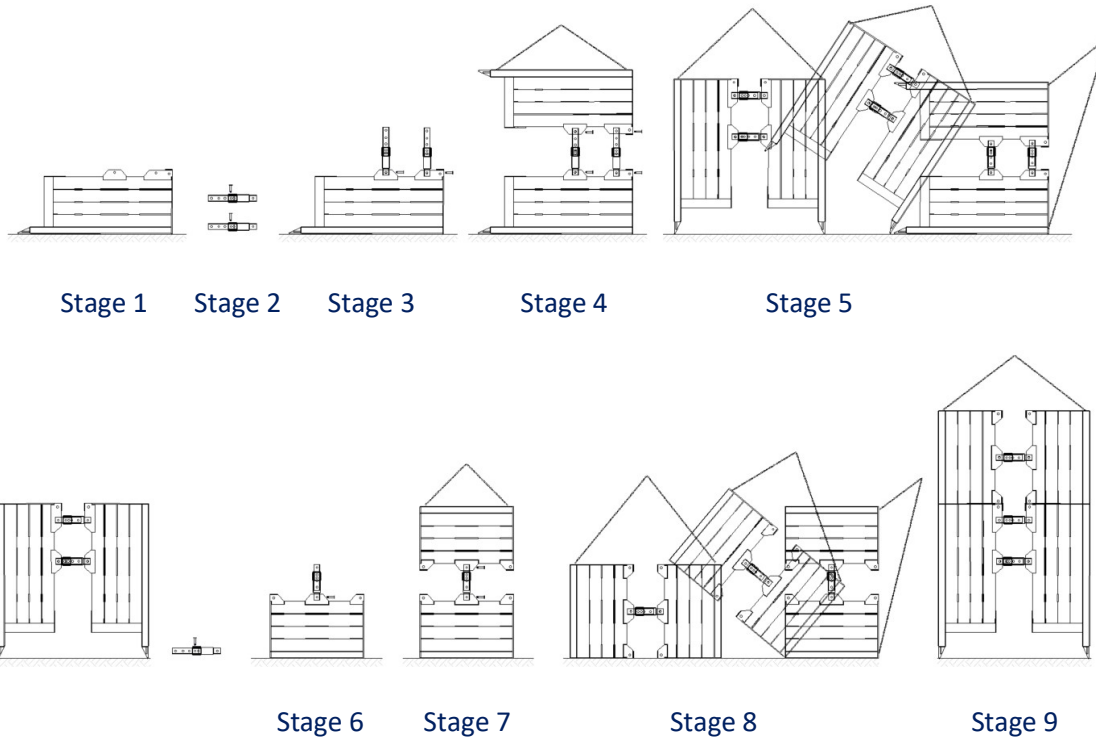

Manhole Box Assembly and Installation Procedure

Stage 1: Prepare the Base Panel

- Place one of the base panels on the ground with the strut connector points facing upwards.

Stage 2: Assemble the Struts

- Assemble 4 struts to the required length:
 - 1 inner struts.
 - 1 spacer with 1 pin and R-clips.

Stage 3: Attach Struts to the Base Panel

- Attach the assembled struts to the base panel using pins and R-clips, ensuring they are securely connected.

Stage 4: Complete the Base Assembly

- Attach the second base panel to the other end of the struts using pins and R-clips to complete the base box assembly.

Stage 5: Position the Base Box Upright

- Using a set of 4-Leg lifting chains, lift and stand the box onto its cutting edge by securing the chains to the upper lifting eye points.

Stage 6: Prepare the Top Panel

- Place one of the top panels on the ground with the strut connector points facing upwards. Attach 2 struts to the top panel as in the previous steps.

Stage 7: Complete the Top Panel Assembly

- Attach the second top panel to the struts using pins and R-clips to complete the top panel assembly.

Stage 8: Position the Top Panels Upright

- Stand the assembled top panels in an upright position, similar to how the base panels were handled.

Stage 9: Attach Top Panels to Base Box

- Lift the assembled top panels and carefully position them on top of the base panels, securing them in place.

Note: For disassembly and removal, follow the procedure in reverse order.

Installation Procedure

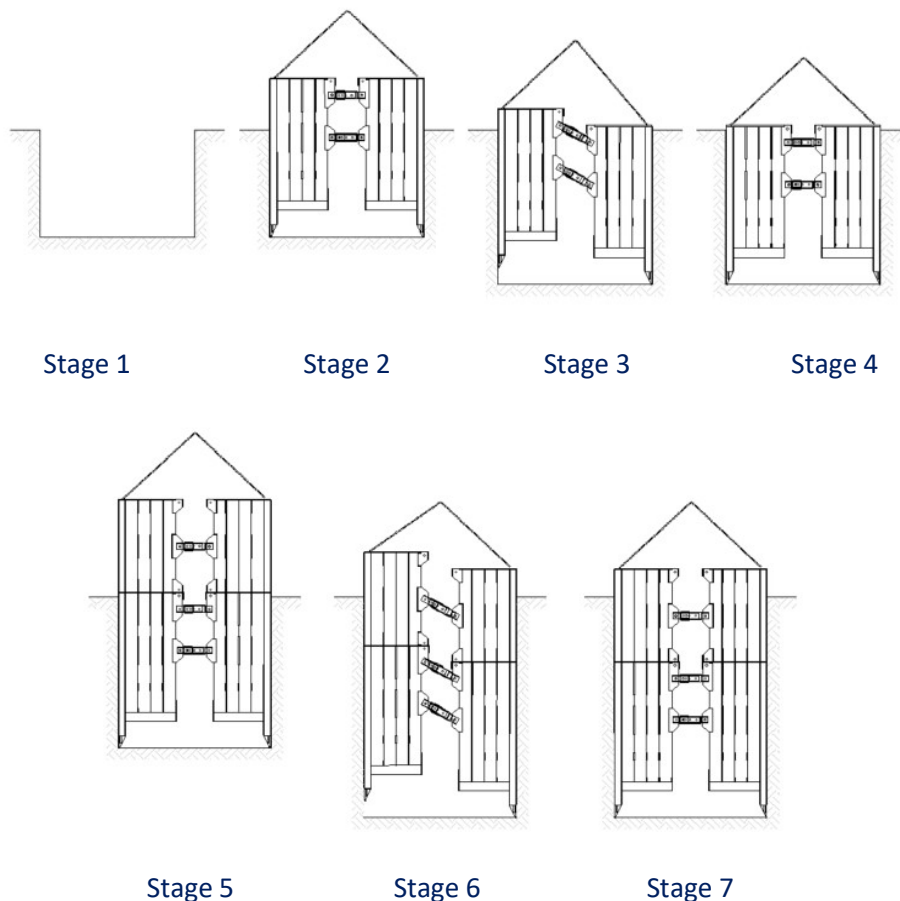

Post-Assembly Check:

- Ensure all pins and 'R' clips are securely in place.
- Lift the box using a 4-leg chain sling attached to the lifting eyes at the top of each manhole box panel.

Stage 1: Initial Excavation

- Dig the manhole approximately 500 – 1000mm deep to the required width.

Stage 2: Position the Box

- Use the 4-leg chain sling to place the box into the excavation.

Stage 3: Lower the Box

- Dig between the box panels and push down on the corners of the panels to lower the box to the correct depth.
- Always dig below the panels while pushing down, focusing on the corners—never in the middle.

Stage 4: Final Adjustments

- Once the box reaches the required depth, ensure the struts are horizontal and perpendicular to the panels before entering the excavation.

Stage 5: Adding an Extension (if needed)

- If an extension is required, do not push the base unit fully into the ground. Leave 300mm of the base panel above ground to attach the extension.
- Use the 4-leg chain sling to position the extension box over the base panel.
- Ensure the struts of the extension are aligned correctly with the base box.
- Attach one side of the extension unit to the base unit first, fitting one connector with 2 pins and R-clips per corner. Repeat for the other side.

Stage 6: Lower the Box

- Dig between the box panels and push down on the corners of the panels to lower the box to the correct depth.
- Always dig below the panels while pushing down, focusing on the corners—never in the middle.

Stage 7&8: Final Depth Adjustment

- When the extension is at the required depth, ensure the struts are horizontal and perpendicular to the panels before entering the excavation.

Extraction Procedure

The method of extraction should be determined by a thorough Risk Assessment.

Due to consolidation, extracting the Manhole Box (MHB) may be more challenging than its installation. Follow these guidelines to ensure safe and efficient extraction:

Use Proper Extraction Points:

- Use only the extraction/lifting points located on the underside of the driving cap.
- Ensure that the chain sling used is strong enough for this operation.

Safety Precautions:

- Be aware that chains may snap if improperly used, posing a risk of severe injury. Therefore, never allow personnel to be near the lift during the extraction process.

Methods of Extraction (listed in increasing order of difficulty):

- **Straight Pull:**

- i. Attach the chain sling to the two extraction/lifting points on each panel.
- ii. Lift the MHB using all four legs of the chain sling.

- **Half Pull:**

- i. Attach the chain sling to the two extraction/lifting points on one panel only and lift that panel.
- ii. When it reaches its maximum movement, remove the chain sling and connect it to the other panel. Lift the second panel.
- iii. Repeat this procedure until the MHB is fully extracted.

- **Single Pull:**

- i. Attach a single leg of the chain sling to one extraction/lifting point and raise the corner of each panel in turn.
- ii. Once the MHB moves freely, remove it using the straight pull method.

Product Notes: 4.0m Standard Manhole Box

- **Safety Precautions:**
 - Do not use any unsupported part of the excavation for access.
 - Always leave the top of the box **100mm** above the surrounding ground level.
 - Ensure all '**R**' clips are fitted to the pins.
 - Do not use more than 2 **extension units** on a box.
 - Ensure no voids exist between box panels and trench sides to prevent sideways movement.
 - Do not leave the base of the box floating above excavation level.
- **End Closure:**
 - Use end closure panels when closing the trench end. Do not use box struts as trench sheet supports unless advised by GAP Group Engineering.
- **Usage Guidelines:**
 - Only use the boxes in configurations shown by competent persons and following GAP Group installation guidelines.
 - Avoid use in very weak ground or where significant groundwater is present.
 - Exercise caution when selecting a lifting machine due to the box's weight; use timber packers to separate panels during stacking.
- **Special Considerations:**
 - In cohesive or very weak soils, the earth pressure/adhesion on panels may increase over time, potentially requiring additional extraction force.
 - Do not fly the box above the excavation base.
 - Inspect all lifting points for damage before each operation.
- **Personnel Safety:**
 - Always enter the manhole box via a ladder located within the box, never from an unsupported edge.
 - No personnel are allowed within the excavation until the box is fully installed.
 - Personnel must not be inside the excavation during lifting or extraction operations.
 - Do not climb up or down the struts.
 - Never move the box when personnel are inside.