

ZENMUSE L2

User Manual

v1.2 2024.07

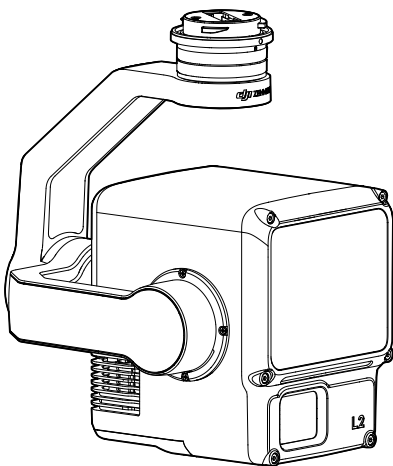



This document is copyrighted by DJI with all rights reserved. Unless otherwise authorized by DJI, you are not eligible to use or allow others to use the document or any part of the document by reproducing, transferring or selling the document. Users should only refer to this document and the content thereof as instructions to operate DJI UAV. The document should not be used for other purposes.

Searching for Keywords

Search for keywords such as “battery” and “install” to find a topic. If you are using Adobe Acrobat Reader to read this document, press Ctrl+F on Windows or Command+F on Mac to begin a search.

Navigating to a Topic

View a complete list of topics in the table of contents. Click on a topic to navigate to that section.

Printing this Document

This document supports high resolution printing.

Using This Manual

Legends

⚠ Important

💡 Hints and Tips

Video Tutorials

Go to the address below or scan the QR code to watch the tutorial videos, which demonstrate how to use the product safely.



<https://enterprise.dji.com/zenmuse-l2/video>

Warnings

1. This product is a precision instrument. DO NOT drop it and handle with care.
2. DO NOT expose the LiDAR to strong sources of energy such as a laser beam or any other LiDAR in use. Otherwise, the LiDAR may be permanently damaged.
3. If highly accurate point cloud data is required, it is not recommended to use the L2 in low visibility conditions such as foggy or rainy weather. Otherwise, the detection range may be reduced leading to point cloud noise. Refer to the [LiDAR Usage Scenario](#) section for more information.
4. DO NOT touch the optical window of the product. Dust and stains on the optical window can negatively affect the performance. Use compressed air or a wet lens cloth to clean the optical window correctly. Refer to the [Storage, Transportation, and Maintenance](#) section for more information on how to clean optical windows.
5. DO NOT touch the surface of the lens with your hand. Be careful to avoid scratching the surface of the lens with sharp objects. Otherwise, the quality of images may be affected. Clean the surface of the camera lens with a soft, dry, clean cloth. DO NOT use substances containing alcohol, benzene, thinners, other flammable substances, or alkaline detergents to clean or maintain the RGB Mapping Camera.
6. When not in use, store the product in the storage case and replace the desiccant packet as necessary to prevent fogging of the lenses due to excessive ambient humidity. If the lenses fog up, the water vapor will usually dissipate after powering on the device for a while. It is recommended to store the product in an environment with a relative humidity of less than 40% and temperature range of 15° to 25° C (59° to 77° F).
7. DO NOT place the product under direct sunlight, in areas with poor ventilation, or near a heat source such as a heater.
8. DO NOT repeatedly power the product on or off. After powering off, wait at least 30 seconds before powering back on. Otherwise, the product life will be affected.

9. Under stable laboratory conditions, the product achieves an IP54 protection rating by IEC 60529 standards. The protection rating is not permanent and may reduce over an extended period.
10. Make sure there is no liquid on the surface or in the port of the gimbal.
11. Make sure the gimbal is securely installed on the aircraft and the microSD card slot cover is properly closed.
12. Make sure the surface of the gimbal is dry before opening the microSD card slot cover.
13. DO NOT remove or insert the microSD card when taking a photo or recording a video.

Contents

Using This Manual	1
Legends	1
Video Tutorials	1
Warnings	1
Product Profile	5
Introduction	5
Overview	5
Installation	5
Remote Controller Controls	7
DJI Pilot 2 App	8
Basic Features	8
Point Cloud LiveView	10
Point Cloud Preview	11
Point Cloud Playback	11
Point Cloud Merging	12
Field Data Collection	14
Getting Started	14
Area Route	14
Recording Point Cloud Data	14
Terrain Follow	16
Waypoint Route	17
Set Waypoints	17
Live Mission Recording	18
Route Parameters	18
Power Line Follow	20
Preparation	20
Plan and Perform the Task	20
Complete the Task	22
Manual Flight	23
Task Quality Report	23
Point Cloud Data File Description	25
PPK Data Acquisition	25

Office Data Processing	27
Downloading DJI Terra	27
Reconstruction Procedures	27
LiDAR Description	29
Non-repetitive Scanning Method	29
Repetitive Scanning Method	29
Point Cloud Density	30
LiDAR Usage Scenario	31
Maintenance	32
Log Export	32
Firmware Update	32
Using DJI Pilot 2	32
Using microSD Card	32
Update Status Alarm	33
L2 Calibration	33
Re-calibrating the Internal and External Parameters	33
Restoring the Internal and External Parameters to Default Settings	34
Storage, Transportation, and Maintenance	34
Storage	34
Transportation	34
Maintenance	35
Specifications	36

Product Profile

Introduction

The ZENMUSE™ L2 integrates a LiDAR module, a high-accuracy IMU, and an RGB mapping camera on a 3-axis stabilized gimbal, which can be used with specified compatible DJI™ aircraft. With Point Cloud LiveView, users can take a quick view of the 3D point cloud effect in the DJI PILOT™ 2 app. When used with DJI TERRA™, the L2 offers a complete solution that generates point cloud output and extracts ground points to generate DEM results, which efficiently completes highly accurate reconstructed models of complex structures.

Overview

1. Gimbal Connector
2. Pan Motor
3. Roll Motor
4. Tilt Motor
5. microSD Card Slot
6. RGB Mapping Camera
7. LiDAR

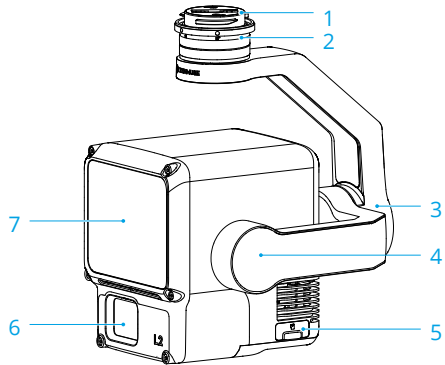

Installation

The L2 can be mounted to MATRICE™ 300 RTK (requires DJI RC Plus) or Matrice 350 RTK aircraft.

1. Remove the gimbal cap and lens cap.

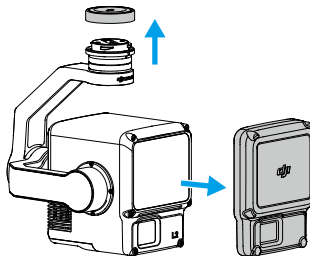

2. Press the button on the aircraft used for detaching the gimbal and camera. Rotate and remove the gimbal cap on the aircraft.
3. Align the white dot on the gimbal with the red dot on the aircraft and insert the gimbal.
4. Rotate the gimbal lock to the locked position by aligning the red dots.

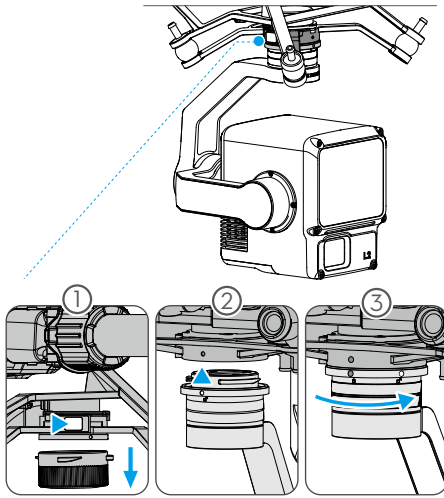

- To ensure the mapping accuracy, make sure the L2 is mounted on a single downward gimbal connector with the cable connected to the right USB-C port (when facing the aircraft).
 - Make sure the gimbal connector on the aircraft is positioned correctly when mounting. Otherwise, the payload cannot be mounted.
 - Only remove the payload after powering off the aircraft.
 - Remove the payload by pressing the button on the aircraft to detach the gimbal and camera.
 - Make sure the microSD card slot cover is firmly in place to prevent dust or moisture entering during usage or transportation.
 - To avoid burns, DO NOT touch the camera case and the optical window when powering on.
 - Detach the gimbal from the aircraft during transportation or storage. Otherwise, the service life of the damper balls may be shortened or they may even be damaged.
-

Remote Controller Controls

With the buttons on the DJI RC Plus remote controller, users can switch display modes between point cloud and visible light live views, preview the point cloud effect, and control the gimbal and camera.

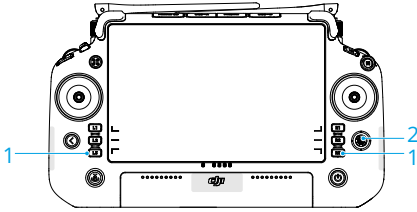

1. L1/L2/L3/R1/R2/R3 Buttons

Go to Camera View in DJI Pilot 2 to view the specific functions of these buttons. Refer to the [DJI Pilot 2 App](#) section for details.

2. 5D Button

View and customize the 5D button functions in DJI Pilot 2.

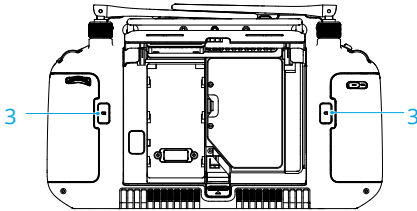

3. Customizable C1/C2/C3 Buttons

Customize the function of these buttons in DJI Pilot 2.

4. Left Dial

Adjust the tilt of the gimbal.

5. Record Button

Press once to start or stop recording.

6. Focus/Shutter Button

Press the button halfway down for autofocus and all the way down to take a photo.

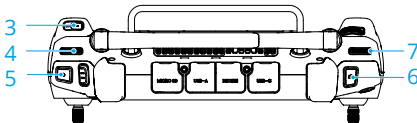

7. Right Dial

Adjust the pan of the gimbal.

DJI Pilot 2 App

In the DJI Pilot 2 app, users can perform a flight task or use Manual mode to record point cloud data. After the flight task, the user can preview the 3D models or even merge models collected from multiple flight tasks.

Basic Features

In Camera View, the touch interface can display a live view and offers professional photography configurations.

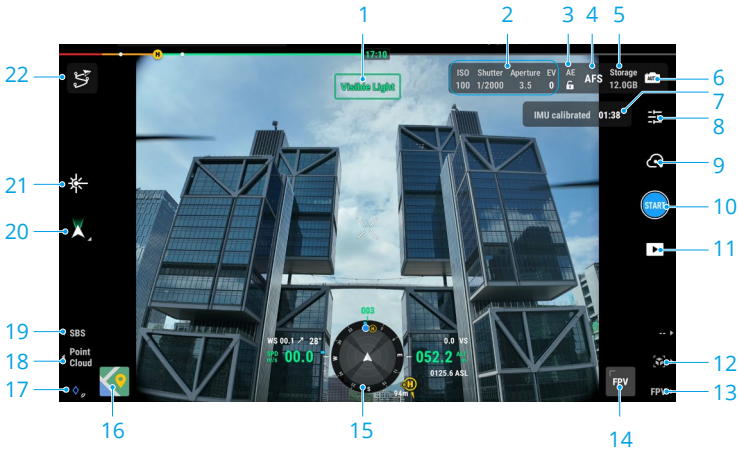

1. View Type

Displays the current camera type including the visible light view, the LiDAR view, and the side-by-side view.

2. Camera Parameters

Displays the current camera parameters.

3. Auto Exposure Lock

Tap to lock the current exposure value.

4. Focus Mode

Tap to switch between MF (manual focus), AFC (continuous autofocus), and AFS (single autofocus).

5. Storage Info

Displays the available storage capacity of the microSD card.

6. Exposure Settings

The L2 supports Auto, S, A, and M exposure modes. EV, AE lock, ISO, shutter, and other

parameters can be configured accordingly in different exposure modes.

7. IMU Calibration Status

Tap Calibrate to perform an IMU calibration to calibrate the LiDAR's inertial navigation system and increase the accuracy of data reconstruction.

A calibration flight should be performed at both the start and end of a flight. Make sure there are no obstacles within a 30m radius of the start and end points.

8. Camera Settings

Tap to enter the photo and video settings. The settings may vary according to different recording modes.



• Dewarping is disabled by default. Users can tap  > Dewarping in the camera settings to enable this function to eliminate or reduce distortion and vignetting in the visible light view.

9. Recording Mode (Shutter/Video Record/Point Cloud Record)

Tap to switch between photo, video, and point cloud recording modes.

10. Shooting Button (Shutter/Video Record/Point Cloud Record)

Tap to take photos or start and stop recording video or point cloud data.

11. Playback

Tap to enter the album to view and download photos and videos stored in the microSD card. Select the point cloud data file to preview the 3D model. Refer to [Point Cloud Playback](#) for details. Select multiple files to view the merging models. Refer to [Point Cloud Merging](#) for details.

12. Press the R2 button on the remote controller to preview the current point cloud model during fieldwork. Refer to [Point Cloud Preview](#) for details.

13. Press the R3 button on the remote controller to switch to FPV camera view.

14. FPV Live View

Tap to display the FPV camera view on the screen. Users can maximize or minimize the view.

15. Navigation Display

In Camera View, the horizontal speed, wind speed, gimbal pitch angle and pitch scale, and the inclination of the gimbal relative to the ground are shown on the left of Navigation Display. The right shows the altitude, relative altitude, vertical obstacle sensing information, and vertical speed bar.

16. Map View

Tap to display the map view on the screen. Users can maximize or minimize the view.

17. Laser PinPoint

Press the L3 button on the remote controller to add a PinPoint in the center of the screen. Tap to select a PinPoint on the map to view the distance between the subject and the aircraft or the altitude, latitude, and longitude of the subject. The laser PinPoints can be projected onto the live view.

18. Press the L2 button on the remote controller to switch between the visible light view and the LiDAR view.

19. Press the L1 button on the remote controller to switch to side-by-side display with visible light and LiDAR live view.

20. Gimbal Mode

Displays the current gimbal status as follow mode. Tap to select an action such as gimbal recenter, gimbal pan recenter, gimbal tilt down, or gimbal down, or switch to gimbal free mode.

21. Laser Rangefinder (RNG)

The cross hair in the center of the live view will turn red, which means the laser rangefinder is pointing at the subject and measuring the distance between the subject and the aircraft, as well as the altitude, latitude, and longitude of the target.

22. Flight Route

Tap to enter the flight route library. Users can create and view all flight tasks and more.

Point Cloud LiveView

With Point Cloud LiveView, users can take a quick view of the real-time point cloud effect using the LiDAR view or side-by-side view.

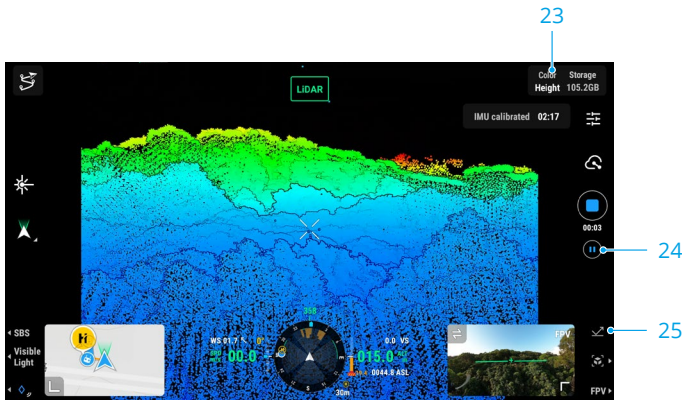

23. Coloring Coding

Tap to select a rendering mode including reflectivity, height, distance, and RGB.

24. Pause Button

Tap to pause recording and tap again to resume.

25. Press the R1 button on the remote controller to switch the rendering mode.

Point Cloud Preview

Press the R2 button on the remote controller during a flight task to preview the point cloud 3D model recorded in real time.

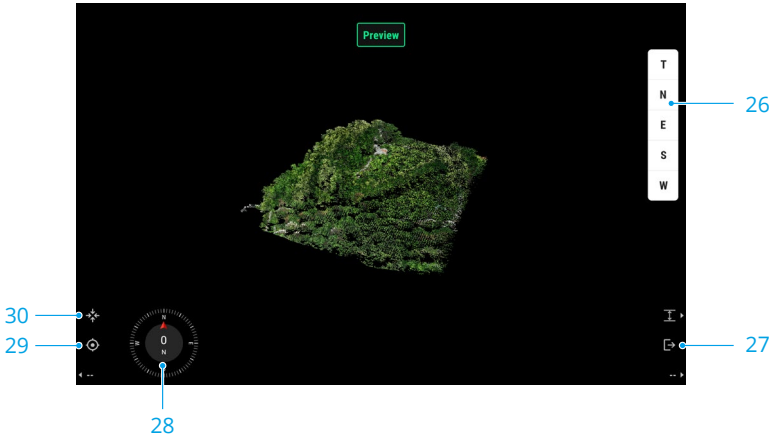

26. Tap to view the point cloud model from above or in the direction of north, east, south, or west.
27. Press the R2 button on the remote controller to exit the preview.
28. Displays the current orientation.
29. Press the L2 button on the remote controller to view the point cloud model beneath the aircraft.
30. Press the L1 button on the remote controller, the model will recenter and zoom in or out to display the whole model.

Point Cloud Playback

Tap  to enter the album and download the point cloud data files to preview the 3D models directly*, allowing users to check the quality on-site and improve work efficiency.

* The model displayed in point cloud playback is generated using sparse point clouds.

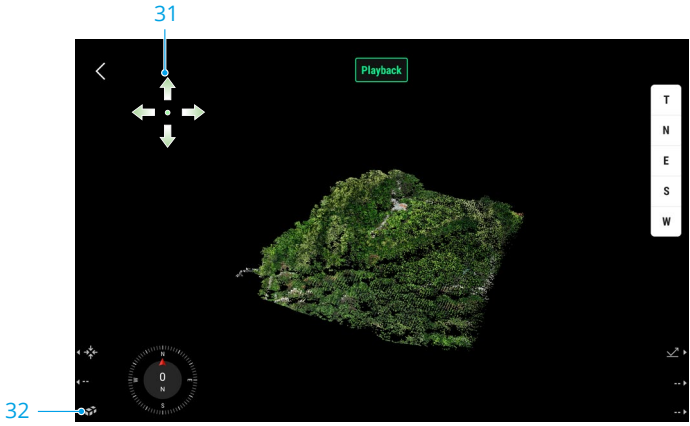

31. Screen Gestures

Displays the supported control gestures when entering the view for the first time.

32. Point Cloud Merging

Press the L3 button on the remote controller to select multiple point cloud data files and view the merging model.

Point Cloud Merging

The app supports the inspection of the results by alignment of multiple point cloud models captured from different flight tasks and reviews the voids and gaps in the merging models.

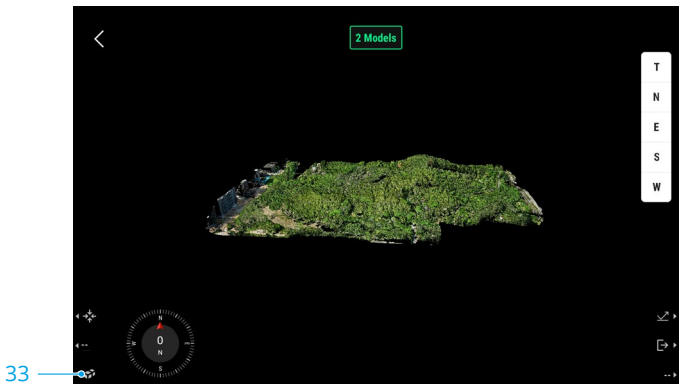

33. Press the L3 button on the remote controller to select more point cloud data files to merge.



- Make sure the aircraft and the remote controller are connected when viewing the point cloud models.
 - The point cloud data file cannot be processed when it is less than 2 kB. It is recommended to record point cloud data for longer than 2 minutes with IMU Calibration enabled to ensure the data is effective.
 - To clear the cache, enter the album to select and delete the downloaded files or tap Data and Privacy on the home page and then tap DJI Pilot Cache Management to clear all downloaded point cloud data files.
-

Field Data Collection

In the DJI Pilot 2 app, users can perform a flight task (Area Route, Waypoint Route, and Linear Route) or use Manual mode to record point cloud data. After each task, the app will generate a task quality report to show the validity of the data.



- Make sure to remove the microSD card after at least 60 s of stopping the shuttering or the point cloud recording. Otherwise, the accuracy may be reduced or the data file may be damaged.

Getting Started





1. Make sure the payload is correctly installed on the single downward gimbal connector of the aircraft and that the aircraft and remote controller are linked after powering on.
2. Go to Camera View in DJI Pilot 2, select *** and then Precise Positioning Setting. Choose the RTK service type, and then make sure that the status of RTK positioning and heading both display FIX. Refer to [PPK Data Acquisition](#) to learn more about data processing if the network or the remote controller video transmission signal is poor.
3. Adjust the camera parameters on the upper right corner of Camera View according to the surroundings. Make sure the photo is well exposed. Tap  to switch exposure modes. It is recommended to set Auto mode for recording point cloud data.

Area Route



When using the area route, the aircraft can automatically complete the data collection of the planned area along the s-shaped route according to the route parameters. Terrain follow flight can be performed in the area route task.

Recording Point Cloud Data

Enter Camera View in DJI Pilot 2 and tap , select Create a Route, and then Area Route to create a flight task.

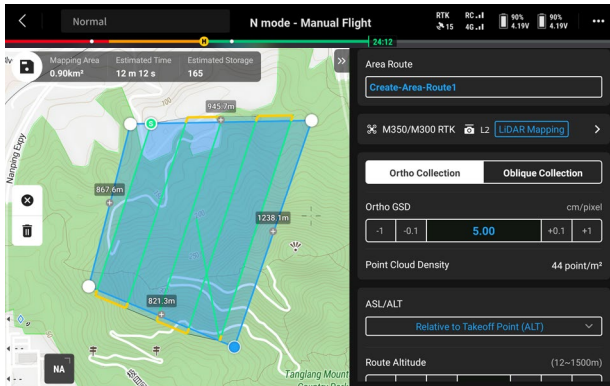
1. Tap on the map view, and drag the boundary point to adjust the range of the mapping area. Tap  in the middle of the boundary point to add a point. Tap  to delete the selected boundary point, and click  to delete all boundary points. Tap  to confirm the mapping area.



2. Choose the aircraft, and then select Zenmuse L2, LiDAR Mapping.
3. Click OK after completing the Payload Settings, then set the flight route parameters and Advanced Settings.
4. Tap  to save the task and tap  to upload and execute the flight task.
5. After the flight task, users can preview the 3D models or even merging models collected from multiple flight tasks.
6. Power off the aircraft after completing the task and remove the microSD card from the L2. Insert the microSD card into a computer and check the point cloud data and other files in the DCIM folder.



- Refer to [Route Parameters](#) for more information.
- For LiDAR Mapping, it is recommended to set the Side Overlap (LiDAR) to above 20%, the Scanning Mode to Repetitive, the altitude to 150 m, the flight speed to 15 m/s, and also to enable IMU Calibration.
- It is recommended to disable Dewarping and set Forward Overlap (Visible) and Side Overlap (Visible) to default parameters in a Photogrammetry task.

Terrain Follow

Set the altitude mode to AGL (altitude relative to ground) to enable the terrain follow function. By importing the DSM file including the altitude information or downloading the DEM file from internet, the app will generate a flight with altitude changes to ensure the relative height of the aircraft and the ground below remains unchanged.

Preparing Files

The DSM files of the mapping area can be obtained using the following two methods:

1. Importing Local File
 - Collect the 2D data of the mapping area and perform a 2D reconstruction using DJI Terra by selecting Mapping Scenarios. A gsddsm.tif file will be generated and can be imported to the microSD card of the remote controller.
 - Download the terrain mapping data from a geobrowser.
2. Downloading from Internet

DSM files can be directly obtained by downloading the open source data of the ASTER GDEM V3 geoid database.



- Make sure the DSM file is a geographic coordinate system file, not a projected coordinate system file. Otherwise, the imported file may not be recognized. It is recommended that the resolution of the imported file should be no more than 10 meters.
- Make sure that the mapping area is within the range of the DSM file.





- The open-source geoid database may have errors. DJI is not responsible for the accuracy, authenticity, or validity of the data. Pay attention to the flight environment. Fly with caution.
-

Importing Files

1. Set the altitude mode to AGL and tap Select DSM File. Tap  and select Download from Internet or Import Local File. Choose the file and tap Import, and wait for the file to be imported.
2. The imported files will be displayed in the list.

Planning a Flight Task

1. Set the altitude mode to AGL and tap Reselect to select a file from the DSM file list.
2. Edit the parameters in Area Route. Set the terrain follow height and enable IMU Calibration.
3. Select  to save the task and select  to upload and execute the flight task.
4. Power off the aircraft after completing the task and remove the microSD card from the L2. Insert the microSD card into a computer and check the point cloud data and other files in the DCIM folder.

Waypoint Route

Waypoint Route can be planned in two ways: Set Waypoints or Live Mission Recording. Use Set Waypoints to create a route by adding editable waypoints on the map. Use Live Mission Recording to create a route by recording the waypoint location of the aircraft along the route.

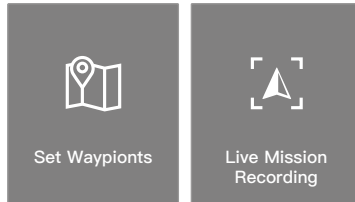

Set Waypoints

Tap Create a Route, Waypoint, and then Set Waypoints.

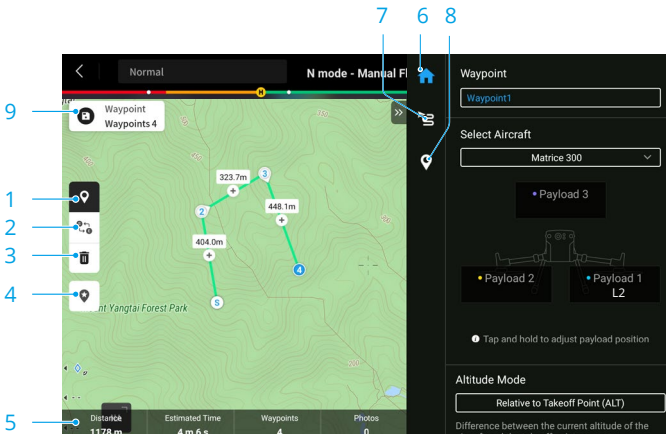

1. Enable or disable waypoint settings. Tap to add and edit waypoints on map when enabled.
2. Reverse Path: tap to swap the start and endpoint to reverse the flight path. S refers to the start point.
3. Delete Selected Waypoints: tap to delete the selected waypoints.
4. Point of Interest (POI): tap to enable the POI function and a POI will be displayed on the map. Drag to adjust its position. After a POI is added, the aircraft yaw can be set as facing the POI, so that the aircraft nose points at the POI during the task. Tap this icon again to disable the POI function.
5. Flight Route Information: displays the flight length, estimated flight time, waypoint quantity, and photo quantity.
6. Parameters List: edit the route name, select the aircraft and payload, set the altitude mode and payload settings.

7. Flight Route Settings: the settings are applied to the entire route, including safe takeoff altitude, ascend to start point, aircraft speed, aircraft altitude, aircraft yaw, gimbal control, waypoint type, completion action, and IMU Calibration.
8. Individual Waypoint Settings: select a waypoint and set its parameters. Tap < or > to switch to the previous or next waypoint. The settings are applied to the selected waypoint, including aircraft speed, aircraft altitude, aircraft yaw mode, waypoint type, aircraft rotation direction, gimbal tilt mode, waypoint actions, longitude, and latitude.
9. Save: tap to save the flight route. Select  to upload and execute the flight task.

Live Mission Recording

Enter Camera View and tap . Tap Create a Route > Waypoint, and then Live Mission Recording to create a flight mission.

1. Control the gimbal to point at the subject. Press the C1 button on the remote controller to add a waypoint. The number of waypoints will be added accordingly.
2. Tap  to save and generate the flight route. Tap the flight route name at the top left to view and edit the flight route settings. There have two editing modes: Set Waypoints or Edit In-Flight.

Route Parameters

Specifications	Description
Return Mode	Supports 5 returns: single return (strongest), dual return, triple return, quad return, and penta return.
Sampling Rate	Supports 240 kHz scanning frequency.
Scanning Mode	Supports both repetitive scanning and non-repetitive scanning. Repetitive scanning is suitable for topographic mapping, with higher accuracy and even point cloud scans. Use non-repetitive scanning for electricity and forestry data collection to generate more complete tree trunk and electrical transmission tower models.
RGB Coloring	When enabled, the user can color the point cloud using the photographs captured by the RGB mapping camera (enabled by default). It is recommended to disable the function during night operation. The photographs can also be used for 2D and 3D reconstruction.
IMU Calibration	It is recommended to enable IMU Calibration. The aircraft flies a Calibration Flight at the start point, end point, and the yellow segments of a flight route.
Collection Type	It is recommended to select Ortho Collection in LiDAR Mapping.
GSD	GSD is the ground sampling distance of the orthophotos taken on the first route, i.e., the distance between two consecutive pixel centers measured on the ground. The larger the GSD value, the lower the resolution of the orthophotos.

Altitude Mode	<p>Relative to Takeoff Point (ALT): the altitude of the aircraft relative to the takeoff point. It is recommended to use this option for a flat mapping area with no undulations and set the altitude to 150 m.</p> <p>ASL (EGM96): the altitude of the aircraft relative to the EGM96 geoid.</p> <p>Altitude Relative to Ground (AGL): the altitude of the aircraft relative to the ground below. Set the altitude mode to AGL to enable the terrain follow function and it is recommended to set the Terrain Follow Height to 150 m. Before using the terrain follow function, please import the DSM or DEM file including the altitude information.</p>
Flight Route Altitude	The altitude of the flight route of a flight task.
Elevation Optimization	It is recommended to enable this option for orthophoto operation. When enabled, the aircraft will fly to the center of the mapping area to collect a set of oblique images to optimize the elevation accuracy.
Flight Route Speed	The operating speed of the aircraft after entering the flight route. This speed is related to the forward overlap ratio.
Course Angle	The route direction is parallel to the longer side of the mapping area by default.
Completion Action	It is recommended to set the completion action as Return to Home.
Side Overlap Ratio	<p>Side overlap ratio is the overlap ratio of two pictures taken on two parallel paths.</p> <p>The default laser side overlap ratio is 20%. If the mapping area has large fluctuations or higher point cloud density is required, it is recommended to increase the overlap ratio.</p>
Forward Overlap Ratio	<p>Forward overlap ratio is the overlap ratio of two pictures captured consecutively in the same heading along the flight path.</p> <p>It is recommended to set the forward overlap ratio (Visible) as 80% to capture orthophotos during point cloud data recording.</p>
Margin	The distance of the flight area beyond the mapping area. The purpose of setting the margin is to ensure the edge accuracy of the mapping area.
Photo Mode	The default selection is Timed Interval Shot.
Safe Takeoff Altitude	<p>After taking off, the aircraft will fly up to the safe takeoff altitude (relative to the takeoff point), then fly to the start point of the flight route.</p> <p>* If the aircraft starts a flight task during flight, the safe takeoff altitude will not take effect.</p>
Takeoff Speed	The flight speed after reaching the flight route altitude and before entering the flight route. It is recommended to set it to the maximum to improve operational efficiency.

Power Line Follow

Power Line Follow is used for point cloud collection of power lines. The L2 can automatically identify wire channels and branching lines, and the aircraft will follow the selected power line to collect point cloud data.

Preparation

In addition to the preparation required for field data collection, it is recommended to mount the CSM Radar to the aircraft when performing power line follow tasks to ensure flight safety. After installing the CSM Radar, enable Horizontal Radar Obstacle Avoidance in Obstacle settings and set the obstacle braking distance to 10 m.

Plan and Perform the Task

1. Fly the aircraft to a position within 50 m diagonally above the transmission tower. Adjust the gimbal to ensure the tower is displayed in the camera view. The identification results may be inaccurate if the aircraft is directly above the tower or the camera does not capture the tower.
2. Tap  to create a task and set the parameters.

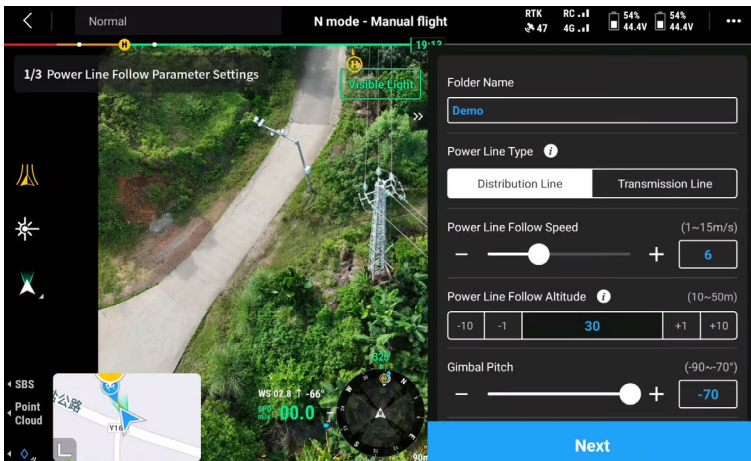

- a. Edit the folder name.
- b. Select the power line type.
Select between Distribution Line and Transmission Line. The identification accuracy may be decreased if the selected power line type is inconsistent with the actual situation.
- c. Set the flight parameters.
Set the appropriate flight speed, altitude, and gimbal pitch angle according to the situation. The altitude is the height of the aircraft relative to the highest point of the

power line. It is recommended to set the altitude to twice the value of the speed to avoid missing scans (for example, if the speed is 10 m/s, set the altitude to 20 m).

d. IMU Calibration

When enabled, a prompt will be displayed in the app at the start and end of the task. Make sure there are no obstacles within 30 m in front of the aircraft, and then perform a calibration flight.

e. Set the point cloud recording parameters.

It is recommended to select triple return, with the sampling frequency set to 240 kHz and in non-repetitive scanning mode. When RGB Coloring is enabled, the user can color the point cloud using the photographs captured by the RGB mapping camera.



• The results are affected by factors such as the diameter and material of the power line, and the tower width. It is recommended to adjust the parameters according to the actual situation.

3. Tap Next and complete the calibration flight if IMU Calibration is enabled, the app will automatically display the identified power lines.
4. After selecting the power lines, tap Start and the aircraft will automatically adjust the altitude and record the point cloud data according to the selected power lines.
5. The aircraft will hover automatically when multiple power lines are detected, and then continue with the flight task after selecting the lines.



- When the aircraft fails to identify power lines, manually adjust the altitude and gimbal pitch angle and try again until the aircraft descends to an altitude of 20 m from the highest point of the power lines.
- The aircraft will not respond to the remote controller stick movements during the flight task. Press the flight pause button or switch the flight mode on the remote controller to exit the task and manually control the aircraft.
- Make sure to check for obstacles around the aircraft using the FPV camera view, especially when the CSM Radar is not installed. In case of an emergency, promptly control the aircraft using the remote controller.
- It is recommended to set the max flight altitude to higher than the tallest obstacle in the operation area to ensure flight safety. The task will be ended automatically if the altitude of the aircraft exceeds the set value.

Complete the Task

1. Tap  to complete the task, the point cloud data files will be saved to the corresponding folders. The task will also be ended automatically in the following situations:
 - No power lines are detected.
 - When RTH is started.
 - The flight pause button on the remote controller is pressed.
 - When the flight mode is switched.
 - When an obstacle is detected. The aircraft will brake and enter obstacle avoidance mode.
 - The aircraft is disconnected from the remote controller.

2. After completing the task, a PinPoint will be added at the position of the aircraft. The Navigation Display will show the distance from the aircraft to the PinPoint when performing a new power line follow task. When the distance between the aircraft and the PinPoint is less than 10 m, the scanned power lines will be marked among the identified lines in the app.



The following scenarios may result in inaccurate identification or abnormal termination of the task during the flight task:

- Multiple parallel power lines in close proximity, such as near substations.
 - The distance between adjacent transmission towers is less than 7 m.
 - The distance between the power lines and ground vegetation is less than 2 m.
 - The presence of numerous linear objects from the top-down perspective, such as buildings, street lamp, and billboards.
-

Manual Flight

1. Fly the aircraft to an appropriate height and tap Calibrate to start a calibration flight. To ensure flight safety, enable obstacle sensing and make sure the area shaded red on the map is clear of obstacles.
2. Fly the aircraft to the target and adjust the gimbal to an appropriate angle. Tap  to start point cloud recording after setting the camera parameters.



• It is recommended that the target be 5 to 150 meters away from the payload. Note that the accuracy may decrease when the distance between the target and the payload is less than 30 m.

3. Press the L1/L2 button on the remote controller to switch the display, and press the R2 button to preview the model recorded in real time during flight.
4. Tap  again to finish recording. It is recommended to perform IMU Calibration again after recording.
5. After the flight task, the user can preview the 3D models or even merge models collected from multiple flight tasks.
6. Power off the aircraft after completing the task and remove the microSD card from the L2. Insert the microSD card into a computer and check the point cloud data and other files in the DCIM folder.

Task Quality Report

When finished an Area Route or a Waypoint Route task, a task quality report is generated automatically to display the detailed information of the task and flight route status. Users can mark the route segments with low quality in the report.

1. View the quality report using either of the following methods:

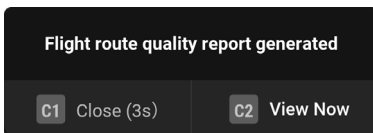

Press the C2 button on the remote controller and follow the prompts

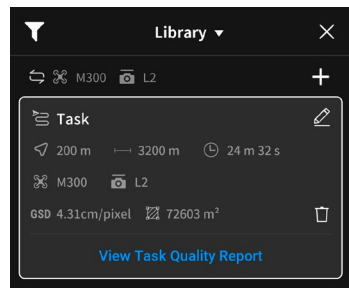

In the flight route library, select the desired route and tap View Task Quality Report.

2. Tap View to open the quality report. The following uses an Area Route as an example.

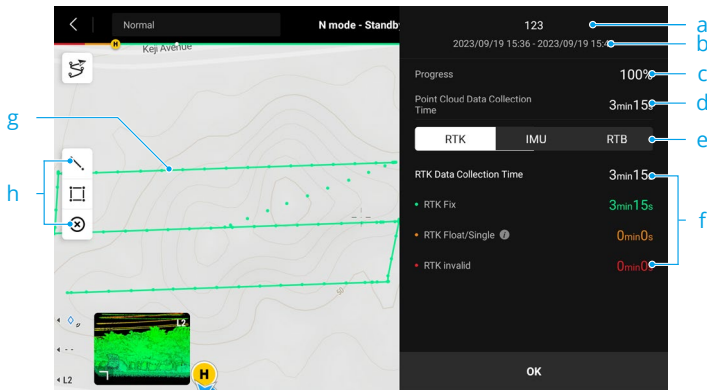

- a. Flight route name
- b. Start and end time of the task
- c. The completed flight route progress when finishing the task.
- d. Display the collection time for point cloud recording.
- e. Switch the displayed information between RTK, IMU, and RTB.
- f. Display the RTK/POS/RTB data collection time and the different status of the flight route segments.
 - The RTK status of the flight route may vary in different segments, including fixed solutions, floating/single solutions, and invalid solutions. The floating/single solutions is available for PPK calculation.
 - Tap IMU to view the POS status of the flight route, including fixed solutions and invalid solutions.
 - Tap RTB to view the base station data status.
- g. Flight Trajectory

The RTK/POS status of the flight route is displayed in different colors. If RGB Coloring is enabled during the flight task, the location of each photo will be displayed as a round dot on the flight trajectory.
- h. Tap to display the Edit Line/Area View. Users can draw areas on the map to mark the segments that need recording again. Set the marked area as a mapping area and create a new Area Route task. Tap  to delete the information.

- ☀️ • The POS data collection time includes the calibration time before and after the task.
- If the same flight route segment is recorded by several times, the quality report will prioritize displaying the results with low quality.

Point Cloud Data File Description

1. The recorded point cloud data is stored in the microSD card. The storage directory is microSD: DCIM/DJI_YYYYMMDDHHMM_NO_XXX (XXX can be edited by the user).
2. The folder contains not only photos taken during the flight but also files with CLC (camera LiDAR calibration file), CLI (LiDAR IMU calibration file), LDR (LiDAR data), RTK (RTK data of main antenna), RTL (compensation data of RTK pole), RTS (RTK data of auxiliary antenna), RTB (base station RTCM data), IMU (IMU raw data), SIG (PPK signature file), LDRT (point cloud file for playback on the app), RPT (point cloud quality report), RPOS (real-time POS solution data), and photos taken during flight.

PPK Data Acquisition

When the mobile network or remote controller video transmission signal is poor, use the RTCM data of the D-RTK 2 Mobile Station or a third-party RTK base station to assist the L2 for data post-processing. Follow the steps below:

1. Check the local operation time from the point cloud data file directory stored in the microSD card.
2. Search for .DAT RTCM files with the same timestamp as the stored files of the D-RTK 2 Mobile Station or third-party RTK base station and follow the steps below:
 - a. If using the D-RTK 2 Mobile Station, copy the .DAT file with the same timestamp in the rctmraw folder to the folder of the point cloud data file directory.
 - b. If using a third-party RTK base station, .oem/.ubx/.obs/.rtcm files are supported. Rename the file the same as the .RTB file in the point cloud data file directory by following the name format in the table below and copy the renamed file to the folder of the point cloud data file directory. DJI Terra will prioritize files in the following order: .oem > .ubx > .obs > .rtcm.

Protocol Type	Protocol Version	Message Type	Name Format
OEM	OEM4, OEM6	RANGE	DJI_YYYYMMDDHHMM_XXX.oem
UBX	--	RAWX	DJI_YYYYMMDDHHMM_XXX.ubx
RINEX	v2.1x, v3.0x	--	DJI_YYYYMMDDHHMM_XXX.obs
RTCM	v3.0	1003, 1004, 1012, 1014	DJI_YYYYMMDDHHMM_XXX.rtcm
	v3.20	MSM4, MSM5, MSM6, MSM7	



- Note that the RTCM file stored in the D-RTK 2 Mobile Station is in UTC time format.
 - If using the D-RTK 2 Mobile Station, users can also directly copy all the base station data files from that day and DJI Terra will automatically merge them.
 - If using a third-party RTK base station, make sure the station supports at least three GNSS systems.
 - When setting up a third-party RTK base station, follow the steps to set the coordinates of the origin for the RTK base station (using RINEX format as an example):
 - a. Erect the RTK base station to a point with known coordinates and record the XYZ coordinates in ECEF format (use a third-party software for format conversion, if necessary).
 - b. Use Notepad to open the RINEX file with the O. file and modify the APPROX POSITION XYZ coordinates of the O. file to the coordinates recorded in step one.
 - Make sure the distance between the RTK base station and the device is less than 15 km. Otherwise, the calculation may fail. Refer to DJI Terra Quality Report for more details.
 - Refer to the D-RTK 2 Mobile Station User Guide for more information.
-

Office Data Processing

Downloading DJI Terra

DJI Terra is required for data processing. Visit <https://enterprise.dji.com/dji-terra/downloads> to download and install DJI Terra. Read the DJI Terra User Manual for more information about how to configure DJI Terra and use reconstructions.

Reconstruction Procedures

Follow the steps below to reconstruct point cloud data in DJI Terra.

1. Launch DJI Terra, select New Mission or Import to create and save a point cloud processing task.
2. Select  on the task editing page and import the folder from the microSD card. The folder will be named according to the time the point cloud data was recorded. The folder contains files with the suffix CLC, CLI, IMU, LDR, RTB, RTK, RTL, and RTS.
3. Configure the point cloud density and output coordinate system settings.
4. Advanced Settings
 - a. Ground Point Type: check the Ground Point Type and select the Ground Type based on actual needs. Flat Ground is suitable for areas with dense buildings or plains. Gentle Slope is suitable for areas such as common mountains and hills. Steep Slope is suitable for areas with great elevation changes such as mountains and valleys.
 - b. Generate DEM: click to generate DEM output. Select By Scale or By GSD to set the resolution of the output.
5. Tap Start Processing to start reconstruction and wait until it is completed.
6. View the point cloud results in different coloring modes.

RGB: displays based on true color.

Reflectivity: displays the corresponding color based on the object's reflectivity, in the scale of 0-255. The range of 0-150 corresponds to diffuse objects with a reflectivity of 0-100%, while 151-255 corresponds to fully reflective objects.

Height: displays the corresponding color according to the height of the target.

Return: display the corresponding color according to the number of returns when collecting data.

Type: displays the ground points and points not categorized if Ground Point Type is selected before processing.



- Read the DJI Terra User Manual for more information about how to process point cloud data.
-

LiDAR Description

The L2 features two point cloud scanning methods. Users can choose between non-repetitive and repetitive scanning methods.

Non-repetitive scanning pattern: the non-repetitive scanning pattern provides a near-circular FOV with a scanning density that is denser in the center of the FOV compared to the surrounding area, resulting in a more comprehensive point cloud model.

Repetitive scanning pattern: the repetitive scanning method provides a flat FOV, which is similar to traditional mechanical scanning methods. It can obtain more uniform and precise scanning results compared to traditional mechanical scanning methods.

Non-repetitive Scanning Method

For the non-repetitive scanning method, the L2 has a horizontal FOV of 70° and a vertical FOV of 75°.

Figure A: the point cloud patterns after 1 s recording by the L2 that is installed on the aircraft and the aircraft is hovering.

Figure B: the point cloud patterns after 10 s recording by the L2 that is installed on the aircraft. The relative altitude is set to 150 m and the flight speed to 10 m/s.

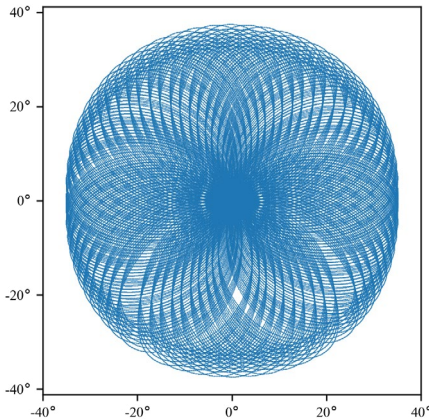

Figure A

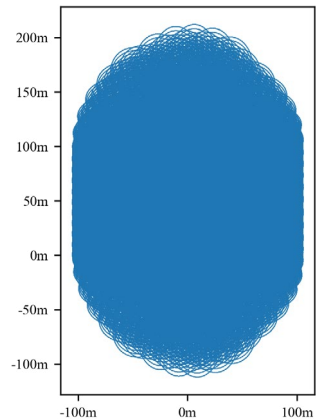

Figure B

Repetitive Scanning Method

For the repetitive scanning method, the scanning repeats approximately every 0.02 s, the horizontal FOV is 70° and the center of the vertical FOV is 3°.

Figure A: the point cloud patterns after 1 s recording by the L2 that is installed on the aircraft and the aircraft is hovering.

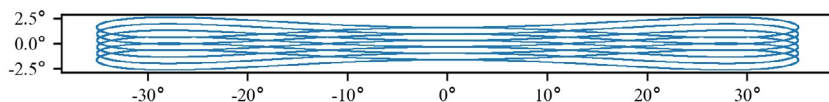

Figure A

Figure B: the point cloud patterns after 10 s recording by the L2 that is installed on the aircraft. The relative altitude is set to 150 m and the flight speed to 10 m/s.

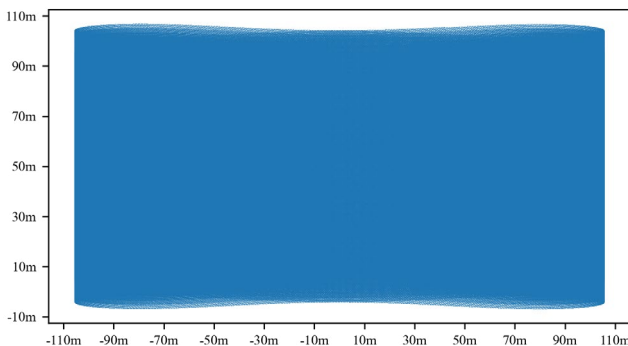
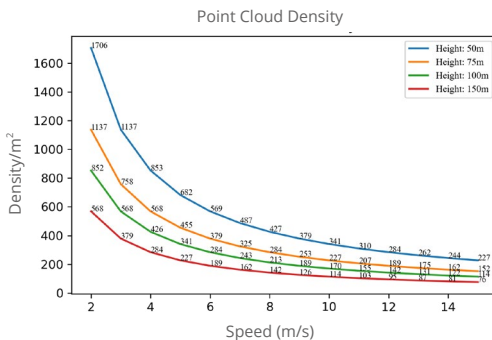

Figure B

Point Cloud Density

The point cloud density will vary depending on the flight altitude, flight speed, and point cloud overlap. The figure below shows the variation of point cloud density with the flight altitude and flight speed when the point cloud overlap is 0%. The point cloud density is $76/m^2$ when the sampling rate is set to 240 kHz, flight altitude to 150 m and flight speed to 15 m/s.



LiDAR Usage Scenario

It is not recommended to use the L2 in scenarios as shown below. Otherwise, the detection range and accuracy of LiDAR may be reduced leading to point cloud noise or voids.

1. Conditions with low visibility such as rainy or foggy weather.
2. Surfaces with strong reflectivity such as water or transparent surfaces, or fully reflective objects or street signs in a close range (<20 m).
3. The distance between the L2 and the target that need high-precision modeling is less than 30 m.*

* The distance varies depending on the environment and accuracy requirement. For example, point cloud data of power line scenarios can be recorded from 10 to 30 m.

Maintenance

Log Export

Run DJI Pilot 2, tap HMS, then Manage Logs, and select L2 to export the log to the microSD card of the payload.

Firmware Update

Using DJI Pilot 2

Online Update

1. Make sure that the payload is correctly installed on the aircraft and the aircraft, remote controller, and other DJI devices are powered on. Make sure all the devices are connected.
2. Run DJI Pilot 2, tap HMS, Firmware Update, and then Update All to update the firmware.

Offline Update

An offline firmware package can be downloaded from the DJI official website to an external storage device such as a microSD card or U disk. Run DJI Pilot 2, tap HMS, and then Firmware Update. Tap Offline Update to select the firmware package for the L2 from the external storage device and tap Update All to update.

Using microSD Card

1. Make sure that the payload is securely mounted onto the aircraft and the aircraft is powered off. Check that there is enough free space on the microSD card and the Intelligent Flight Batteries are fully charged.
2. Visit the Zenmuse L2 product page on the DJI official website and go to Downloads.
3. Download the latest firmware.
4. Once downloaded, copy the firmware file to the root directory of the microSD card.
5. Insert the microSD card into the microSD card slot of the L2.
6. Power on the aircraft. The gimbal and camera perform an auto-check and will start to update automatically. The gimbal will beep to indicate the status of the firmware update.
7. Restart the device after the firmware update is complete.

Update Status Alarm

Alarm	Descriptions
1 short beep	Firmware update detected. Preparing to update
4 short beeps	Updating firmware. Do not stop update
1 long beep followed by 2 short beeps	Firmware update successful
Continuous long beep	Firmware update failed. Try again and contact DJI Support if the problem persists

- ⚠ • Make sure that there is only one firmware update file on the microSD card.
- DO NOT power off the aircraft or detach the gimbal and camera while updating the firmware. It is recommended to delete the firmware update file on the microSD card once the firmware is updated.

L2 Calibration

Major calibration errors may result in issues such as layered point clouds and inaccurate color rendering. Select to calibrate the L2.

Re-calibrating the Internal and External Parameters

1. Collecting Calibration Data

Make sure that there is a facade of the building in the mapping area and the area is larger than 200 m × 200 m. Using Area Route to create a route of about 5 minutes, and enable IMU Calibration, Elevation Optimization, RGB Coloring, Single return and Repetitive scanning. Set the side overlap ratio to 50%, flight route altitude to 100 m, and speed to 10 m/s. Perform the flight to collect the data.

2. Using DJI Terra to Export Calibration File

Use DJI Terra (v3.9.0 or later) to create a LiDAR Point Cloud Processing task, import the calibration data collected in Step one, and select LiDAR Calibration. Click Export Calibration File after the processing task is completed. The generated calibration file is the .tar file in the lidars/terra_lidar_cali project folder.

It is recommended to check if the point cloud data had any issues such as layered point clouds or inaccurate color rendering. Repeat Steps one and two if there are issues. Proceed to Step three if there are no issues.

3. Calibrating the L2

Copy the calibration file to the root directory of the microSD card, insert the microSD card into the L2, install the L2 onto the aircraft. Power on the aircraft and wait approximately 5 minutes for the calibration to complete.

4. Checking the Result

After the calibration is completed, remove the microSD card from the L2. Insert it to a

computer and check the .txt format log file. The calibration is successful if All succeed is displayed. Users can also record the point cloud data to check whether the time parameter of the .CLI file is updated.

Restoring the Internal and External Parameters to Default Settings

If the calibration results are not satisfactory, the internal and external parameters can be restored to the default settings by following the steps below.

1. Create restoring files
 - a. Restoring the .CLI file: create a new .txt file and name it clear_user_extri_params.txt.
 - b. Restoring the camera parameters: create a new .txt file and name it reset_cali_user.txt. Open the file and write the serial number of the L2 that will be reset with the format SN number: XXXXXXXXXXXXXXX. The serial number is located in the .CLI file and can be viewed in the device version information in the app.
2. Import the file: copy the .txt file that needs to be restored to the root directory of the microSD card, insert the microSD card into the L2 that needs to be calibrated, install the L2 onto the aircraft. Power on the aircraft and wait approximately 5 minutes for calibration to complete.
3. Record the point cloud data and remove the microSD card from the L2. Insert it to a computer and check the .txt log file. The calibration is successful if All succeed is displayed. It is also possible to check whether the time parameter of the .CLI file is restored to the default settings.
4. If restored successfully, delete the restoring .txt files from the microSD card.

Storage, Transportation, and Maintenance

Storage

The storage temperature range for the L2 is from -20° to 60° C (-4° to 140° F). Keep the product in a dry and dust-free environment.

1. Make sure the product is not exposed to environments containing poisonous or corrosive gases or materials.
2. DO NOT drop the product and be careful when placing in or taking out of storage.

Transportation

1. Before transportation, place the product in a suitable box for transportation and make sure it is secure. Make sure to place foam inside the transportation box and that the box is clean and dry.
2. DO NOT drop the product and be careful when carrying it.

Maintenance

1. Under normal circumstances, the only maintenance required for the product is to clean the optical window of the LiDAR sensor. Dust and stains on the optical window can negatively affect the performance of the LiDAR sensor. Make sure to regularly clean the optical window to prevent this from happening.
2. First, check the surface of the optical window to see if cleaning is necessary. If it is necessary to clean it, follow the steps below:
 - a. Use compressed or canned air.

DO NOT wipe a dusty optical window as it will only cause more damage. Clean the optical window with compressed or canned air before wiping the optical window.

It is not necessary to use a wipe if there is no visible stains on the optical window afterward.
 - b. Wipe the stains.

DO NOT wipe using a dry lens tissue as it will scratch the surface of the optical window. Use a wet lens tissue. Wipe slowly to remove the dirt instead of redistributing it on the surface of the optical window. If the optical window is still dirty, a mild soap solution can be used to gently wash the window. Repeat Step B to remove any remaining soap residue.

Specifications

General	
Dimensions	155×128×176 mm
Weight	905±5 g
Power	28 W (typical), 58 W (max.)
IP Rating	IP54
Operating Temperature	-20° to 50° C (-4° to 122° F)
Storage Temperature	-20° to 60° C (-4° to 140° F)
Supported Aircraft	Matrice 350 RTK Matrice 300 RTK (requires DJI RC Plus)
System Performance	
Detection Range ^[1]	450m @50% reflectivity, 0klx 250m @10% reflectivity, 100klx
Point Cloud Rate	Single return: max. 240,000 pts/s Multiple returns: max. 1,200,000 pts/s
System Accuracy ^[2]	Horizontal: 5 cm @ 150 m Vertical: 4 cm @ 150 m
Real-Time Point Cloud Coloring Coding	Reflectivity, Height, Distance, RGB
LiDAR	
Ranging Accuracy (RMS 1σ) ^[3]	2 cm @ 150 m
Maximum Returns Supported	5
Scanning Modes	Non-repetitive scanning pattern, Repetitive scanning pattern
FOV	Repetitive scanning pattern: 70°×3° Non-repetitive scanning pattern: 70°×75°
Minimum Detection Range	3 m
Laser Beam Divergence	0.6 mrad×0.2 mrad
Laser Wavelength	905 nm
Laser Spot Size	Horizontal 4 cm, vertical 12 cm @ 100 m (FWHM)
Laser Pulse Emission Frequency	240 kHz
Laser Safety	Class 1 (IEC 60825-1:2014)
Accessible Emission Limit (AEL)	233.59 nJ
Reference Aperture	Effective Aperture: 23.85 mm (equivalent to circular)
Max Laser Pulse Emission Power Within 5 Nanoseconds	46.718 W
Inertial Navigation System	
IMU Update Frequency	200 Hz

Accelerometer Range	±6 g
Angular Velocity Meter Range	±300 dps
Positioning Accuracy (RTK FIX)	Horizontal: 1 cm + 1 ppm Vertical: 1.5 cm + 1 ppm

RGB Mapping Camera

Sensor	4/3 CMOS, Effective Pixels: 20 MP
Lens	FOV: 84° Format Equivalent: 24 mm Aperture: f/2.8-f/11 Focus Points: 1 m to ∞ (with autofocus)
Shutter Speed	Mechanical Shutter: 2-1/2000 s Electronic Shutter: 2-1/8000 s
Shutter Count	200,000
Photo Size	5280×3956 (4:3)
Still Photography Modes	Single shot: 20 MP Timed: 20 MP JPEG Timed Interval: 0.7/1/2/3/5/7/10/15/20/30/60 s RAW/JPEG + RAW Timed Interval: 2/3/5/7/10/15/20/30/60 s
ISO	Video: 100-6400 Photo: 100-6400
Video Codec and Resolution	H.264, H.265 4K: 3840×2160 @30fps FHD: 1920×1080 @30fps
Video Bitrate	4K: 85Mbps FHD: 30Mbps
Supported File System	exFAT
Photo Format	JPEG/DNG (RAW)
Video Format	MP4 (MPEG-4 AVC/H.264 or HEVC/H.265)

Gimbal

Stabilization System	3-axis (tilt, roll, pan)
Angular Vibration Range	0.01°
Mounting	Detachable DJI SKYPORT
Mechanical Range	Tilt: -143° to +43° Pan: ±105°
Controllable Range	Tilt: -120° to +30° Pan: ±90°
Operation Mode	Follow/Free/Re-center

Data Storage ^[4]

Raw Data Storage	Photo/IMU/Point cloud/GNSS/Calibration files
Point Cloud Data Storage	Real-time modeling data storage

Supported microSD Cards microSD: sequential writing speed 50 MB/s or above and UHS-I Speed Grade 3 rating or above; Max capacity: 256 GB. Use the recommended microSD cards.

Recommended microSD Cards Lexar 1066x 64GB U3 A2 V30 microSDXC
 Lexar 1066x 128GB U3 A2 V30 microSDXC
 Kingston Canvas Go! Plus 128GB U3 A2 V30 microSDXC
 Lexar 1066x 256GB U3 A2 V30 microSDXC

Post-Processing Software

Supported Software DJI Terra

Data Format DJI Terra supports exporting point cloud models in the following formats:
 Point cloud format: PNTS/LAS/PLY/PCD/S3MB
 Trajectory file format: sbet.out/sbet.txt

- [1] Measured using a flat subject with a size larger than the laser beam diameter, perpendicular angle of incidence, and an atmospheric visibility of 23 km. In low-light environments, the laser beams can achieve the optimal detection range. If a laser beam hits more than one subject, the total laser transmitter power is split, and the achievable range is reduced. The maximum detection range is 500 m.
- [2] Measured under the following conditions in a DJI laboratory environment: Zenmuse L2 mounted on a Matrice 350 RTK and powered up. Using DJI Pilot 2's Area Route to plan the flight route (with IMU Calibration enabled). Using repetitive scanning with the RTK in the FIX status. The relative altitude was set to 150 m, flight speed to 15 m/s, gimbal pitch to -90°, and each straight segment of the flight route was less than 1500 m. The field contained objects with obvious angular features, and used exposed hard-ground check points that conformed to the diffuse reflection model. DJI Terra was used for post-processing with Optimize Point Cloud Accuracy enabled. Under the same conditions with Optimize Point Cloud Accuracy not enabled, the vertical accuracy is 4 cm and the horizontal accuracy is 8 cm.
- [3] Measured in an environment of 25° C (77° F) with a subject of 80% reflectivity at a distance of 150 m. The actual environment may differ from the testing environment. The result listed is for reference only.
- [4] Zenmuse L2 supports the Security Code function. Go to Data and Privacy in DJI Pilot 2 and set the code to encrypt the microSD card installed on the camera. Download DJI Decrypt Tool from the DJI official website to decrypt the microSD card on a Windows computer and access the microSD card content.

WE ARE HERE FOR YOU



Contact
DJI SUPPORT

This content is subject to change.

<https://enterprise.dji.com/zenmuse-l2/downloads>

If you have any questions about this document, please contact DJI by sending a message to DocSupport@dji.com.

DJI and ZENMUSE are trademarks of DJI.
Copyright © 2024 DJI All Rights Reserved.