



TRENCHING & SHORING

3.5m Standard Manhole Box Technical Data Sheet

This technical data sheet provides essential information for users of the GAP Group 3.5m Standard Manhole Box System. It highlights key aspects of the Manhole Box Assembly, installation, weight, dimensions, planning, and lifting operations, which should be considered when compiling method statements.

Overview

The 3.5m Standard Manhole Box is a four-sided mechanical excavation support system designed to support trenches up to **5.5m deep**. It is specifically intended for use in manhole construction and is not suitable for other purposes.

System Features

- **Depth Capacity:** Up to 5.5 meters (achievable with 1 base and 2 extensions).
- **Manhole Ring Sizes:** Suitable for ring sizes of 1800mm and 2100mm.
- **Maximum Lateral Earth Pressure:** 40kN/m²
- **Application:** Designed for use with GAP's manhole shutters, enabling rapid manhole construction without the need for workers to enter unsupported excavations.
- **Installation Methods:** Can be installed by an excavator using either the dig and push or excavate and lower method.

Weight

- **Complete Base Box:**
 - Weight: 3042 kg
 - Components: 2 panels, 4 struts, pins and R-clips
- **Complete Extension Box:**
 - Weight: 2116 kg
 - Components: 2 panel, 2 struts, pins and R-clips

Planning & Safety Considerations

When planning for the use of the 3.5m Standard Manhole Box, consider the following:

- **Lifting Operations:** Ensure that the excavator's lifting capacity is sufficient to handle the manhole box components.
- **Assembly & Installation:** Follow safe practices and procedures for assembling and installing the manhole box, as outlined in your method statement.
- **Site Conditions:** Assess site conditions such as soil type, trench depth, and groundwater levels before installation.

Important Notes

- It is assumed that users are familiar with general safety practices relevant to manhole box operations.

For further information or assistance, please contact GAP Group.

Box Component Identification, Range and Dimensions

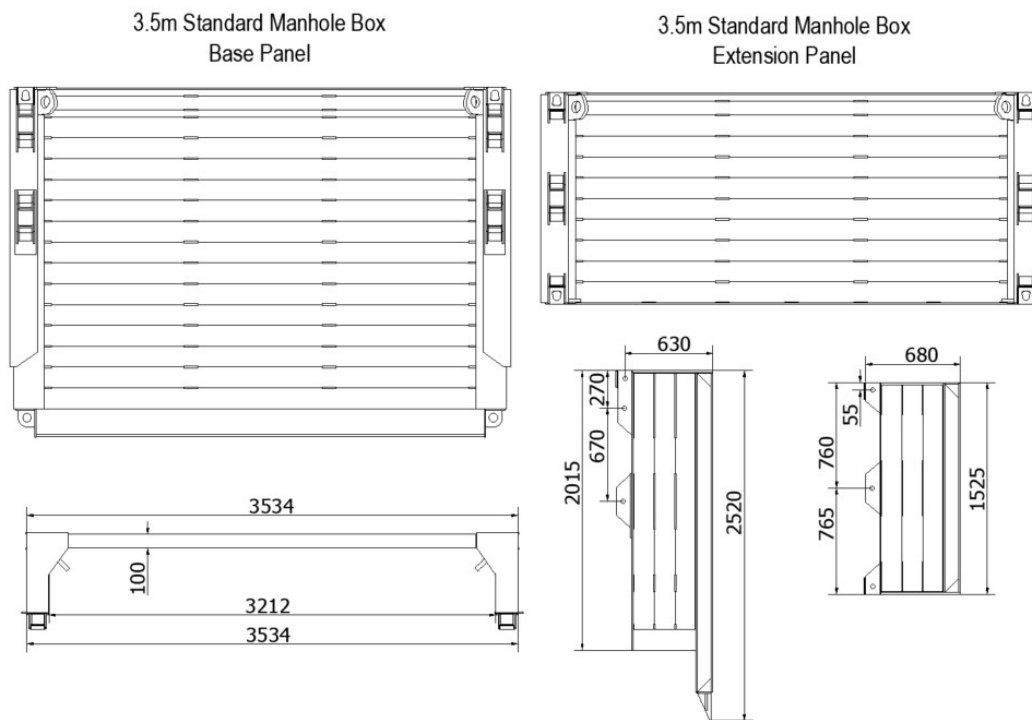

Pin and Struts

There are 8No. pins and 4No. connectors required to attach one base box to the extension box.

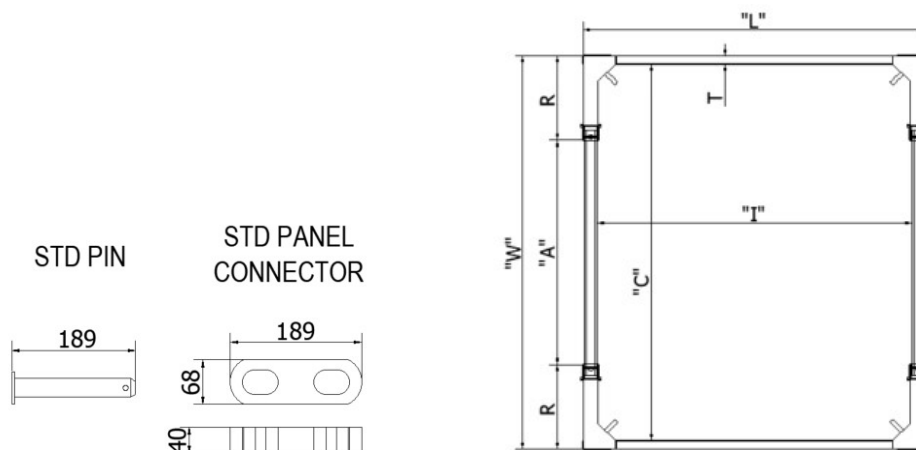

Strut Type	"A" Pin to Pin Length (mm)		"R" Outside Face to Pin Centre (mm)	"C" Internal Clearance (mm)		"I" Internal Clearance (mm)	"W" Overall Width (mm)		Clearance Below Lower Strut (mm)	"L" Overall Length (mm)
	Min	Max		Min	Max		Min	Max		
	Size 0	480		680	630		1540	1740		
Size 1	680	1080	630	1740	2140	3212	1940	2340	1500	3534
Size A	1150	1950	630	2210	3010	3212	2410	3210	1500	3534
Size B	1800	2700	630	2860	3760	3212	3060	3960	1500	3534
Size C	2600	3450	630	3660	4510	3212	3860	4710	1500	3534
*2.0m	750		630	1810		3212	2010		1500	3534
*2.5m	1250		630	2310		3212	2510		1500	3534
*3.0m	1750		630	2810		3212	3010		1500	3534
*3.5m	2030		630	3090		3212	3290		1500	3534



***2.0m, 2.5m, 3.0m and 3.5m Struts are Fixed Struts.**

Struts: There are two types of struts for Standard manhole and Trench boxes.

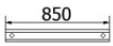
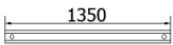
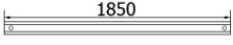
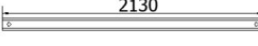
Fixed Standard Struts Manhole Box

2.0m STRUT	
2.5m STRUT	
3.0m STRUT	
3.5m STRUT	

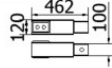
Standard Struts Manhole Box

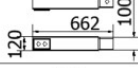
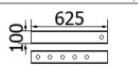
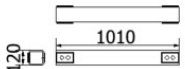
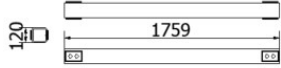
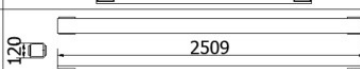
SIZE 0 OUTER STRUT	
SIZE 0 INNER STRUT	
SIZE 1 OUTER STRUT	
SIZE 1 INNER STRUT	
A DOUBLE ENDED OUTER STRUT	
B DOUBLE ENDED OUTER STRUT	
C DOUBLE ENDED OUTER STRUT	

Site Assembly

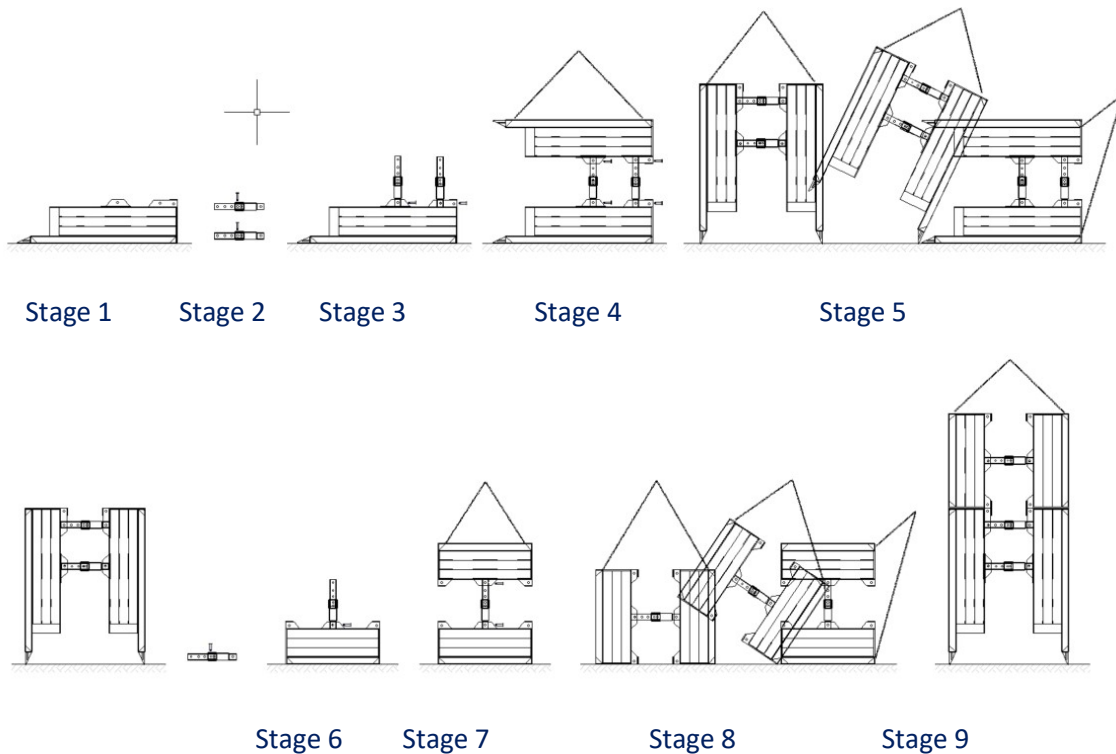

Manhole Box Assembly and Installation Procedure

Stage 1: Prepare the Base Panel

- Place one of the base panels on the ground with the strut connector points facing upwards.

Stage 2: Assemble the Struts

- Assemble 4 struts to the required length:
 - 1 inner struts.
 - 1 spacer with 1 pin and R-clips.

Stage 3: Attach Struts to the Base Panel

- Attach the assembled struts to the base panel using pins and R-clips, ensuring they are securely connected.

Stage 4: Complete the Base Assembly

- Attach the second base panel to the other end of the struts using pins and R-clips to complete the base box assembly.

Stage 5: Position the Base Box Upright

- Using a set of 4-Leg lifting chains, lift and stand the box onto its cutting edge by securing the chains to the upper lifting eye points.

Stage 6: Prepare the Top Panel

- Place one of the top panels on the ground with the strut connector points facing upwards. Attach 2 struts to the top panel as in the previous steps.

Stage 7: Complete the Top Panel Assembly

- Attach the second top panel to the struts using pins and R-clips to complete the top panel assembly.

Stage 8: Position the Top Panels Upright

- Stand the assembled top panels in an upright position, similar to how the base panels were handled.

Stage 9: Attach Top Panels to Base Box

- Lift the assembled top panels and carefully position them on top of the base panels, securing them in place.

Note: For disassembly and removal, follow the procedure in reverse order.

Installation Procedure

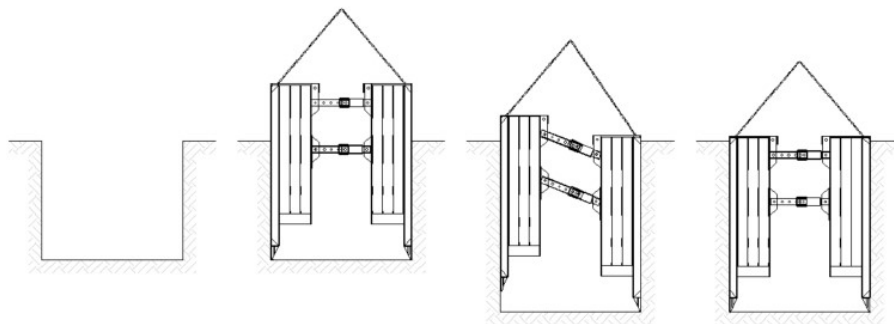

Stage 1

Stage 2

Stage 3

Stage 4

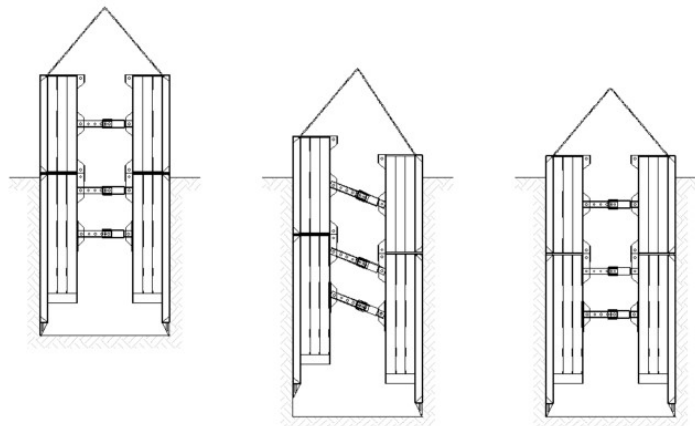

Stage 5

Stage 6

Stage 7

Post-Assembly Check:

- Ensure all pins and 'R' clips are securely in place.
- Lift the box using a 4-leg chain sling attached to the lifting eyes at the top of each manhole box panel.

Stage 1: Initial Excavation

- Dig the manhole approximately 500 – 1000mm deep to the required width.

Stage 2: Position the Box

- Use the 4-leg chain sling to place the box into the excavation.

Stage 3: Lower the Box

- Dig between the box panels and push down on the corners of the panels to lower the box to the correct depth.
- Always dig below the panels while pushing down, focusing on the corners—never in the middle.

Stage 4: Final Adjustments

- Once the box reaches the required depth, ensure the struts are horizontal and perpendicular to the panels before entering the excavation.

Stage 5: Adding an Extension (if needed)

- If an extension is required, do not push the base unit fully into the ground. Leave 300mm of the base panel above ground to attach the extension.
- Use the 4-leg chain sling to position the extension box over the base panel.
- Ensure the struts of the extension are aligned correctly with the base box.
- Attach one side of the extension unit to the base unit first, fitting one connector with 2 pins and R-clips per corner. Repeat for the other side.

Stage 6: Lower the Box

- Dig between the box panels and push down on the corners of the panels to lower the box to the correct depth.
- Always dig below the panels while pushing down, focusing on the corners—never in the middle.

Stage 7: Final Depth Adjustment

- When the extension is at the required depth, ensure the struts are horizontal and perpendicular to the panels before entering the excavation.

Extraction Procedure

The method of extraction should be determined by a thorough Risk Assessment.

Due to consolidation, extracting the Manhole Box (MHB) may be more challenging than its installation. Follow these guidelines to ensure safe and efficient extraction:

Use Proper Extraction Points:

- Use only the extraction/lifting points located on the underside of the driving cap.
- Ensure that the chain sling used is strong enough for this operation.

Safety Precautions:

- Be aware that chains may snap if improperly used, posing a risk of severe injury. Therefore, never allow personnel to be near the lift during the extraction process.

Methods of Extraction (listed in increasing order of difficulty):

- **Straight Pull:**

- i. Attach the chain sling to the two extraction/lifting points on each panel.
- ii. Lift the MHB using all four legs of the chain sling.

- **Half Pull:**

- i. Attach the chain sling to the two extraction/lifting points on one panel only and lift that panel.
- ii. When it reaches its maximum movement, remove the chain sling and connect it to the other panel. Lift the second panel.
- iii. Repeat this procedure until the MHB is fully extracted.

- **Single Pull:**

- i. Attach a single leg of the chain sling to one extraction/lifting point and raise the corner of each panel in turn.
- ii. Once the MHB moves freely, remove it using the straight pull method.

Product Notes: 3.5m Standard Manhole Box

- **Safety Precautions:**
 - Do not use any unsupported part of the excavation for access.
 - Always leave the top of the box **100mm** above the surrounding ground level.
 - Ensure all '**R**' clips are fitted to the pins.
 - Do not use more than **2 extension units** on a box.
 - Ensure no voids exist between box panels and trench sides to prevent sideways movement.
 - Do not leave the base of the box floating above excavation level.
- **End Closure:**
 - Use end closure panels when closing the trench end. Do not use box struts as trench sheet supports unless advised by GAP Group Engineering.
- **Usage Guidelines:**
 - Only use the boxes in configurations shown by competent persons and following GAP Group installation guidelines.
 - Avoid use in very weak ground or where significant groundwater is present.
 - Exercise caution when selecting a lifting machine due to the box's weight; use timber packers to separate panels during stacking.
- **Special Considerations:**
 - In cohesive or very weak soils, the earth pressure/adhesion on panels may increase over time, potentially requiring additional extraction force.
 - Do not fly the box above the excavation base.
 - Inspect all lifting points for damage before each operation.
- **Personnel Safety:**
 - Always enter the manhole box via a ladder located within the box, never from an unsupported edge.
 - No personnel are allowed within the excavation until the box is fully installed.
 - Personnel must not be inside the excavation during lifting or extraction operations.
 - Do not climb up or down the struts.
 - Never move the box when personnel are inside.